

Western Electric

274A Vacuum Tube

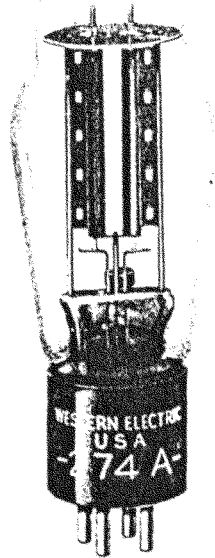

Classification—Full-wave, thermionic high vacuum rectifier

The 274A tube is designed to supply direct current up to 200 milliamperes from an alternating current source. It comprises two filament type diode units with a common filament.

Dimensions—Dimensions, outline diagrams of the tube and base, and the arrangement of electrode connections to the base terminals are shown in Figures 1 and 2.

Base—Medium, four-pin thrust type.

Socket—Standard, four-contact type such as the Western Electric 143B socket.

Mounting Positions—Either vertical or horizontal. If mounted in a horizontal position, the planes of the filament, whose direction is indicated in Figure 2, should be vertical.

Filament Rating

Filament voltage	5.0 volts, a.c. or d.c.
Nominal filament current	2.0 amperes

The filament of this tube is designed to operate on a voltage basis, and should be operated at as near the rated voltage as is practicable.

Characteristics—The current-voltage characteristic of a single diode unit of the 274A tube is shown in Figure 3. The voltage is measured between the plate and a center tap on the filament transformer. Direct-voltage output characteristics as functions of the direct load current for a number of values of applied alternating voltage are given in Figures 4 and 5. The characteristics of Figure 4 are for a choke-input filter such as is shown in circuit A, and those of Figure 5 are for a condenser-input filter such as is shown in circuit B.

Operating Conditions

	R-M-S Alternating Voltage per Plate	Total Rectified Current
	Volts	Milliamperes
Choke-Input Filter	550	160
	*550	200
	*660	160
Condenser-Input Filter	450	140
	*450	**150

*Maximum operating conditions.
**4 MF. maximum filter input capacitance.

A less severe condition should be selected in preference to a maximum operating condition wherever possible. The life of the tube at maximum conditions may be shorter than at less severe conditions.

Double the above listed values of rectified current may be obtained from two tubes by connecting the two plates of each tube together, and using one tube in each side of the circuit.

Effect of Filter—It is evident from the regulation characteristics of Figures 4 and 5 that for a given output current and voltage, the choke-input filter requires a somewhat higher alternating voltage applied to the plates of the tube than the condenser-input filter. With the condenser-input filter, however, the normal charging and discharging of the condenser each half cycle requires the tube to supply relatively large peaks of current during each charging period. The peak current increases in value as the capacitance of the condenser is increased and may be much larger than the average rectified output current, though its duration in such cases is only a short fraction of a cycle. Since for good tube performance, the anode current must be considerably less at every part of the cycle than the total emission current from the filament, the maximum permissible output current must be limited to such a value that this condition is satisfied. The permissible output current may be larger, therefore, for a choke-input filter, in which the peak anode current is only slightly larger than the output current. The choke-input filter also gives much better regulation than the condenser-input circuit. The choke-input filter, therefore, should always be selected in preference to the condenser-input filter wherever possible. With a condenser-input filter, the capacitance of the input condenser should preferably not exceed 4 microfarads.

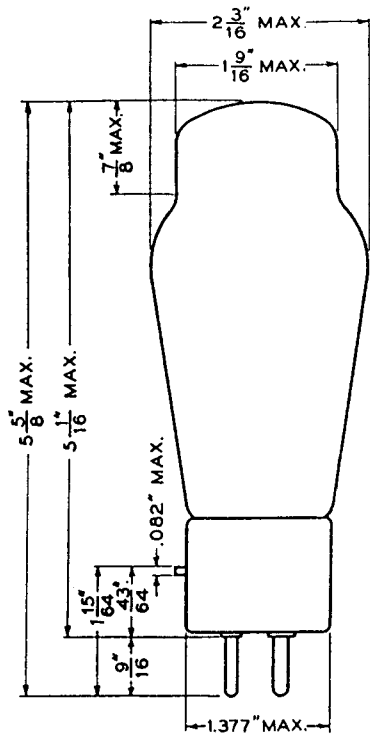

FIG. 1

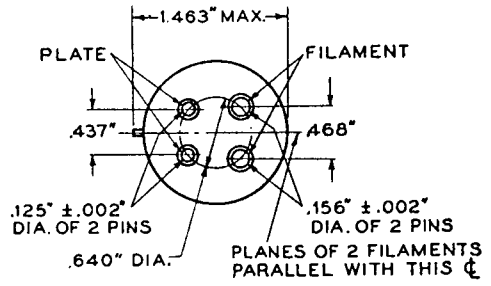

FIG. 2

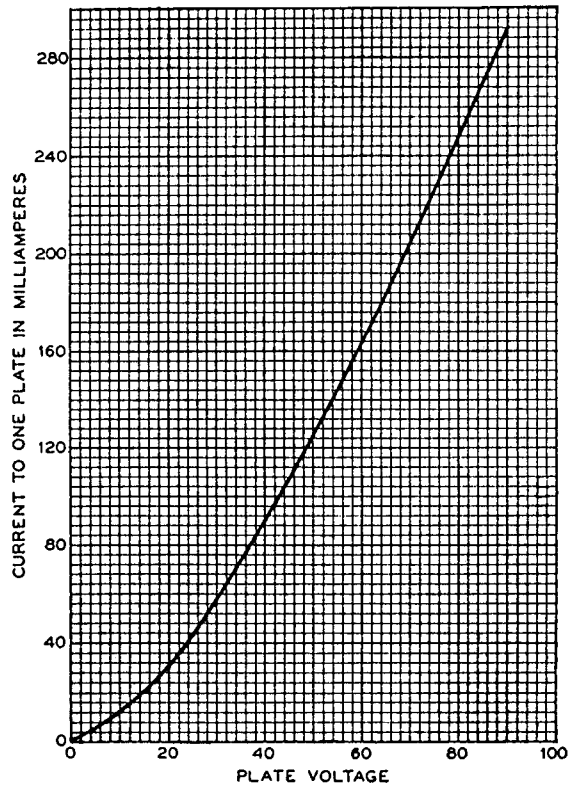

FIG. 3

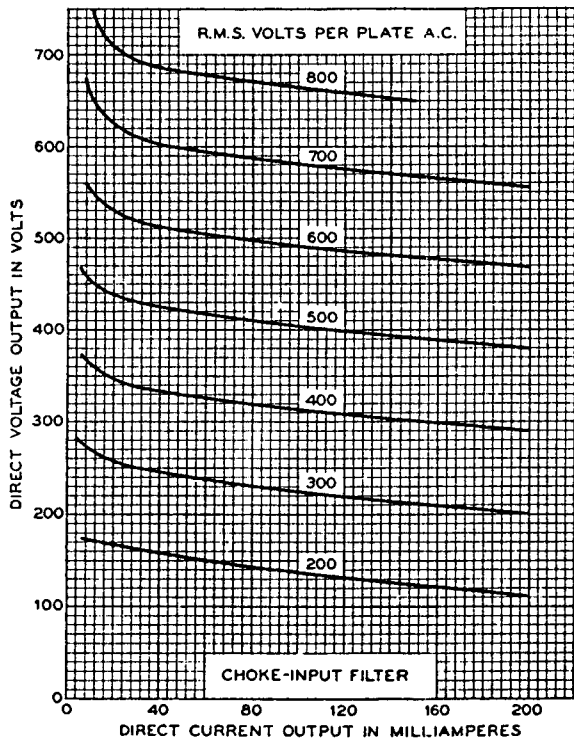

FIG. 4

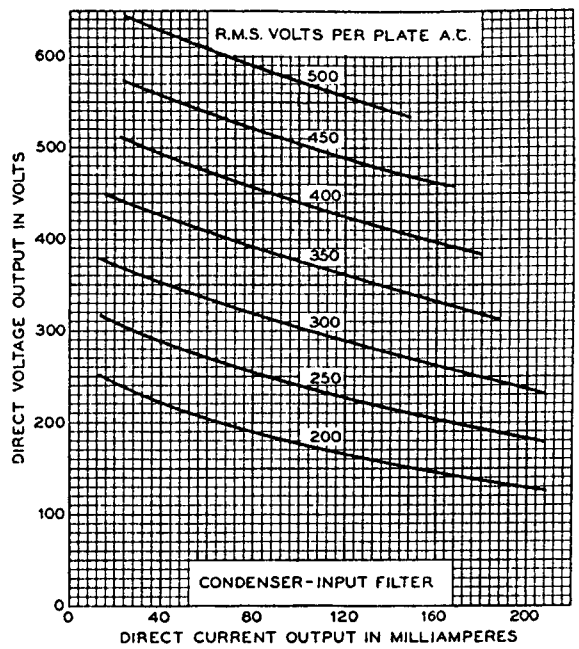
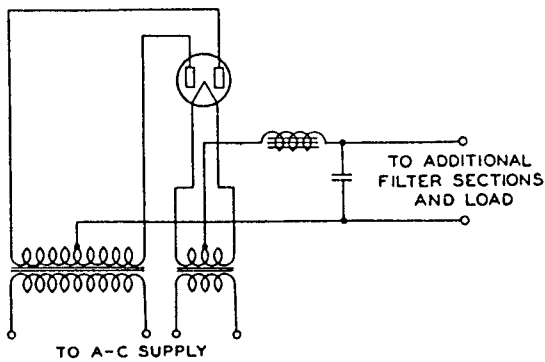
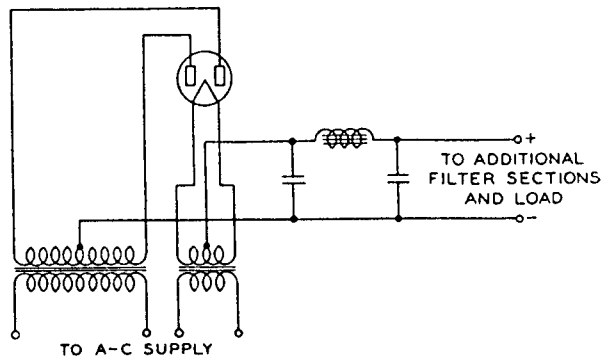

FIG. 5



CHOKE INPUT FILTER
CIRCUIT A



CONDENSER INPUT FILTER
CIRCUIT B